

# solution fires



2026 -2027



## A new generation of highly efficient, authentic and stylish electric fires.

---

The focus of your living space, these fires have been designed and manufactured with optimal controllability of heat, light and sound as the critical elements. Controllable from your handset, via Alexa or through the app on your smart phone or watch, you can customise your fireplace to suit your individual taste. No electric fire, currently on the market, has the level of product features or attention to detail that Solution Fires have as standard, supported by a high level of genuine customer service. For more information about our products, please visit our website [www.solutionfires.co.uk](http://www.solutionfires.co.uk).



**BRITISH COMPANY**  
ESTABLISHED FOR 30 YEARS





## Media Wall Fires

Trueflame <b>150 3DX</b> .....	8-9
Trueflame <b>100 3DX</b> <b>NEW</b> .....	10-11
Pure 1300 Black Series <b>NEW</b> .....	24-25
Pure 1600 Black Series <b>NEW</b> .....	26-27
Pure 1300SL <b>NEW</b> .....	28-29
Pure 1600SL <b>NEW</b> .....	30-31
<b>LUX</b> 650 .....	32-33
<b>LUX</b> 75 Insert .....	34-35
<b>LUX</b> 100 .....	38-39
<b>LUX</b> 125 .....	40-41
<b>LUX</b> 150 .....	42-43
<b>LUX</b> 175 .....	44-45
<b>LUX</b> 200 .....	46-47

## Bioethanol Stove

Willow <b>NEW</b> .....	4-5
-------------------------	-----

## Electric Stoves & Basket

Trueflame Mulberry <b>NEW</b> .....	18-19
Trueflame Elegance <b>NEW</b> .....	20-21
Blackthorn .....	60-61
<b>SLE</b> 25i .....	62
<b>SLE</b> 42s .....	63
<b>LUX</b> 75 Solstice Fire Basket .....	36-37

## Electric Inset Fires

Trueflame <b>16 3DX</b> <b>NEW</b> .....	16-17
Pure 16 <b>NEW</b> .....	22-23
<b>SLE</b> 40i .....	54
<b>SLE</b> 43i .....	55
<b>SLE</b> 43i Glass Fronted .....	56
<b>SLE</b> 43iXD <b>NEW</b> .....	57
<b>SLE</b> 55i .....	58
<b>SLE</b> 60i .....	59
<b>SLE</b> 35i .....	64
Frames & Fascias .....	76-81

## Electric Suites

Sheringham .....	52
Sheringham with Base .....	53
<b>e</b> tronic 560 .....	65
Broadmere .....	66
Denstone .....	67
Riseley .....	68
Arlington <b>NEW</b> .....	69
Hamlin <b>NEW</b> .....	70
Lincoln <b>NEW</b> .....	71
Mayfield <b>NEW</b> .....	72
Springfield <b>NEW</b> .....	73
Provident .....	74-75

# Willow Bioethanol Stove

## Heat Output: 2-3kW

The Willow bioethanol stove is a flueless, real-flame decorative appliance that burns renewable liquid fuel derived from plant-based sources like corn or sugarcane. Its defining characteristic is ventless operation, meaning it does not require a chimney, flue, or gas connection, allowing for near-total flexibility in placement.

## Features

- Fuel Type: Liquid Bioethanol
- Burner Capacity: 1 Litre
- Burn Time: Approx 3 Hours on High Flame
- Control: Manual
- Fuel Bed: Ceramic Log Set
- Construction: Steel & Cast Iron
- Ventilation: Not Normally Required
- Optional Decorative Flue Kit

## Technical Dimensions (mm)

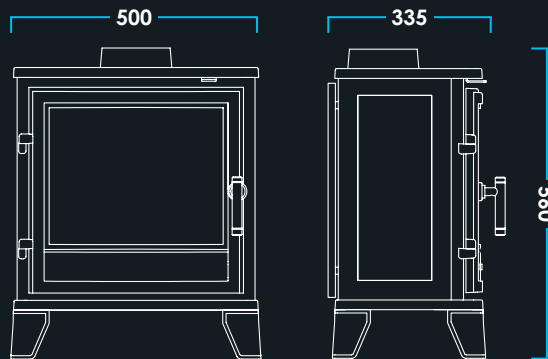

Clearance to Combustibles: 100mm  
Hearth: Non Combustible Material









# TrueFlame 3DX



**Solution Fires have developed a range of pioneering, ultra-high-definition LCD fires that are redefining the electric fire market.**

Featuring a state-of-the-art **4K LCD flame screen**, the TrueFlame range delivers a crystal clear image with cinematic qualities. Designed with meticulous attention to detail and using the latest technology, Solution Fires have developed captivating visual concepts that include a variety of backgrounds, flame types and even a tropical aquarium on the 100 & 150 **3DX** models.

To complement the large range of visual experiences on offer, the TrueFlame range comes with a hand-crafted, premium real log fuel bed. A decorative stone fuel bed is available as an optional extra on certain fires, designed to create a contemporary look for the gas flame or aquarium visual effects. The fuel beds are interchangeable, allowing the fire to be converted as desired.

For optimum control, there are manual and remote capabilities built into the fire whilst the 100 & 150 **3DX** fires can also be controlled by an app.

Every detail of the TrueFlame range has been cleverly engineered to deliver the most realistic visual experience which can be customised to create an attractive optical aesthetic that enhances the ambience of any room.

**Solution Fires - Revolutionising the Future of Electric.**

TF100 **3DX**   TF150 **3DX**   TF16 **3DX**   TF Mulberry **3DX**   TF Elegance **3DX**

# TrueFlame 150 3DX

Heat Output: 1.5kW

## Features

- 4K LCD Flame Screen
- 17 High Definition Visual Concepts
- Premium Handcrafted Real Log Fuel Bed
- Manual and Remote Control
- Stunning 435mm High Viewing Front Glass
- 4 Downlight & Fuel Bed Colours
- Solution Fires App
- Dimmable Downlights & Fuel Bed
- Flickering Fuel Bed
- Only 293mm Deep
- Ultra Quiet Fan Heater

## Optional Extras

- Anti-Reflective Glass
- Decorative Stone Fuel Bed

## Technical Dimensions (mm)

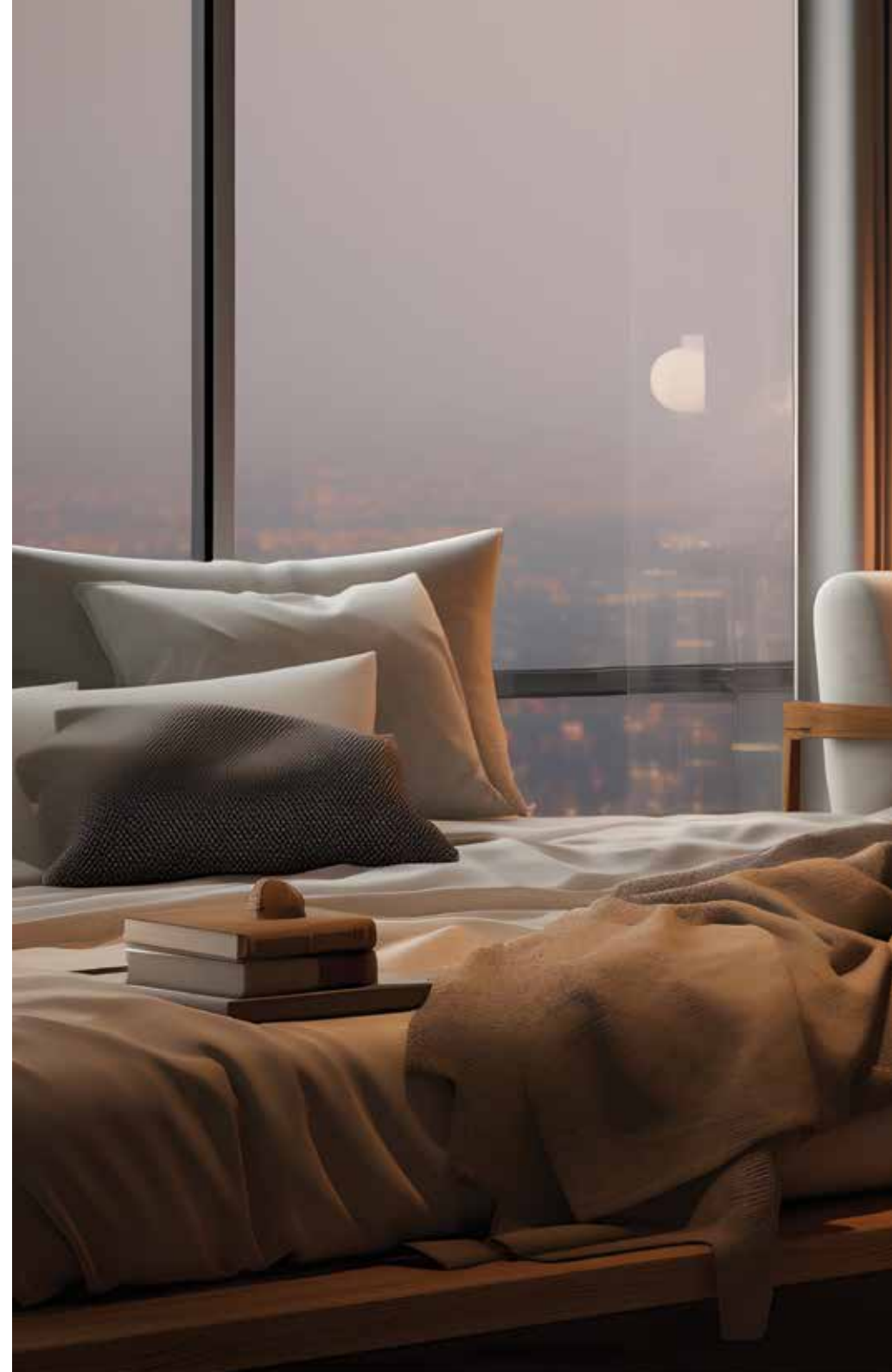
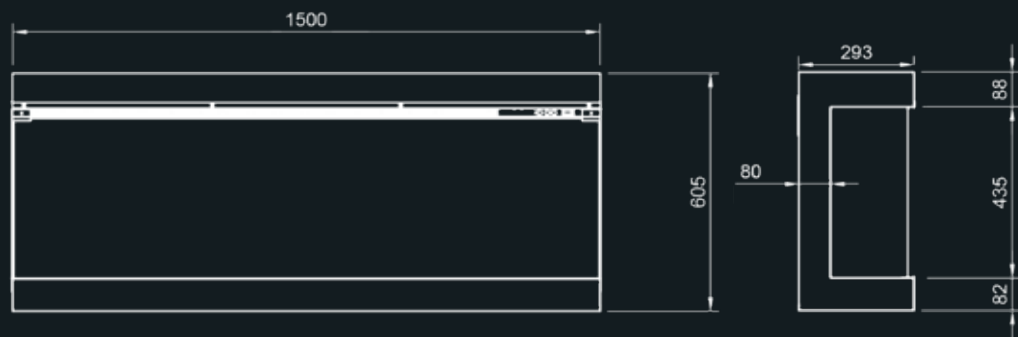



## Installation Options

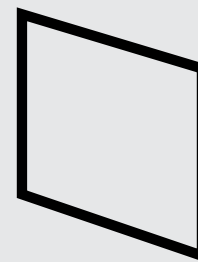

Front Facing

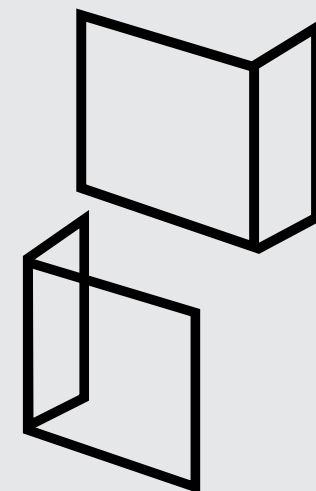

Corner (Left or Right)

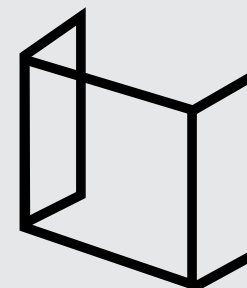

Panoramic

# TrueFlame 100 3DX

Heat Output: 1.5kW

## Features

- 4K LCD Flame Screen
- 17 High Definition Visual Concepts
- Premium Handcrafted Real Log Fuel Bed
- Manual and Remote Control
- Stunning 435mm High Viewing Front Glass
- 4 Downlight & Fuel Bed Colours
- Solution Fires App
- Dimmable Downlights & Fuel Bed
- Flickering Fuel Bed
- Only 293mm Deep
- Ultra Quiet Fan Heater

## Optional Extra

- Anti-Reflective Glass
- Decorative Stone Fuel Bed

## Technical Dimensions (mm)



new

Installation Options

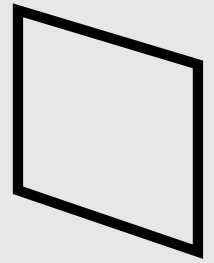

Front Facing

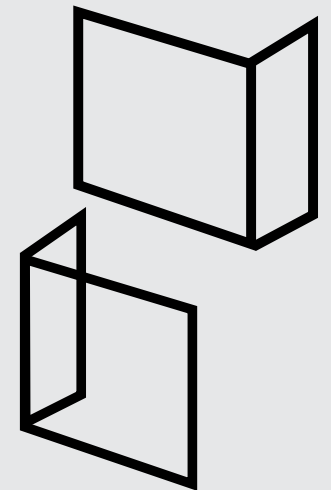

Corner (Left or Right)

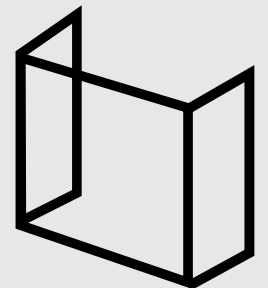

Panoramic

**High Flame**  
Black Background



**Low Flame**  
Black Background



**Electric Rotisserie Flame**  
Black Background





**Steel Chamber**

High Flame



**Ribbed Chamber**

High Flame



**Slate Chamber**

High Flame

### Gas Flame

Black Background  
Decorative stone Fuel Bed

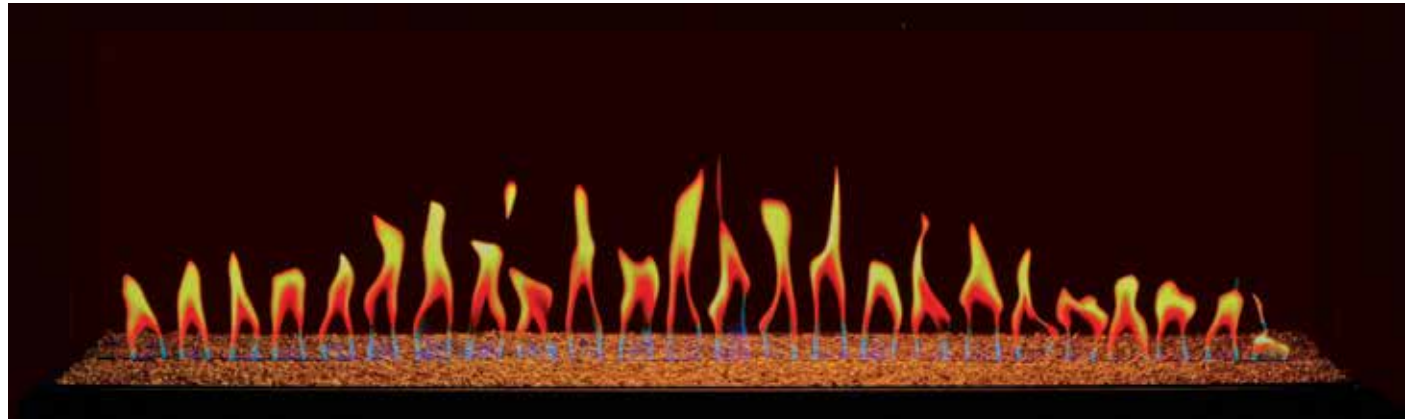

### Gas Flame

Steel Chamber  
Decorative Stone Fuel Bed



### Tropical Aquarium

Decorative Stone Fuel Bed





# TrueFlame 16 3DX

Heat Output: 1-2kW

## Features

- 4K LCD Flame Screen
- 3 High Definition Background Options
- High & Low Flame Options
- Premium Handcrafted Real Log Fuel Bed
- Remote Control
- Choice Of Frames And Facias (Pages 76-81)

## Technical Dimensions (mm)

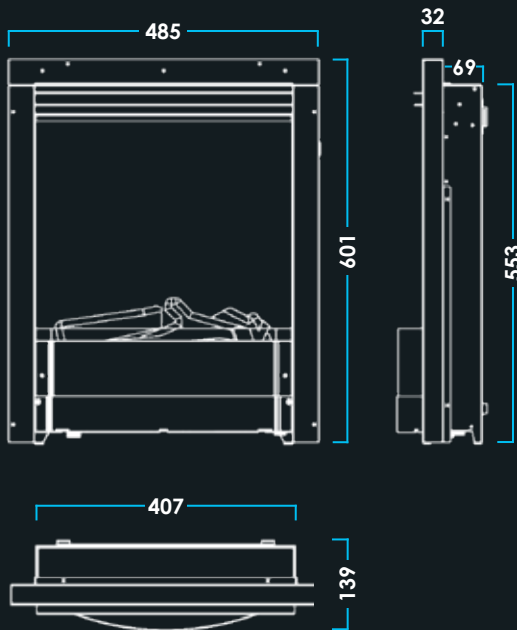

new



# TrueFlame Mulberry

Heat Output: 2kW

## Features

- 4K LCD Flame Screen
- 2 High Definition Background Options
- TrueFlame 3DX Flame Effect
- Rotisserie Flame Effect
- Premium Handcrafted Real Log Fuel Bed
- Manual & Remote Control
- Mirrored Side Panels
- Decorative Flue Collar Included

## Optional Extras

- Decorative 1m Flue Pipe Extension
- **Decorative Flue Kit including:**
  - 1 x 400mm Length Flue Pipe
  - 1 x 90 Degree Bend
  - 1 x Wall Spigot
  - 1 x Stove Spigot

## Technical Dimensions (mm)

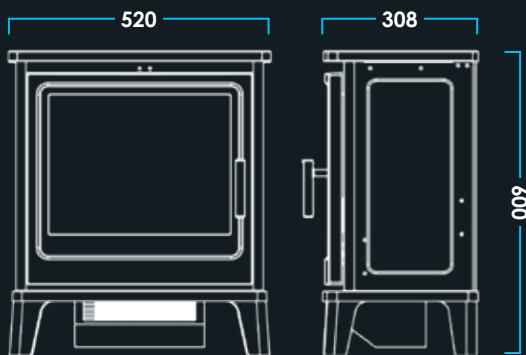

new



# TrueFlame Elegance

Heat Output: 0.75kW - 1.5kW

## Features

- 4K LCD Flame Screen
- 2 High Definition Background Options
- TrueFlame 3DX Flame Effect
- Rotisserie Flame Effect
- Premium Handcrafted Real Log Fuel Bed
- Manual & Remote Control

## Optional Extras

- Decorative 1m Flue Pipe Extension
- **Decorative Flue Kit including:**
  - 1 x 400mm Length Flue Pipe
  - 1 x 90 Degree Bend
  - 1 x Wall Spigot
  - 1 x Stove Spigot

## Technical Dimensions (mm)



new



# Pure 16

Heat Output: 1.5kW - 2kW

## Features

- 2 Flame Colour Options
- 2 Fuel Bed Colour Options
- Loose Decorative Log Fuel Bed
- Remote Control
- Choice of Frames & Facias (Pages 76-81)

## Technical Dimensions (mm)

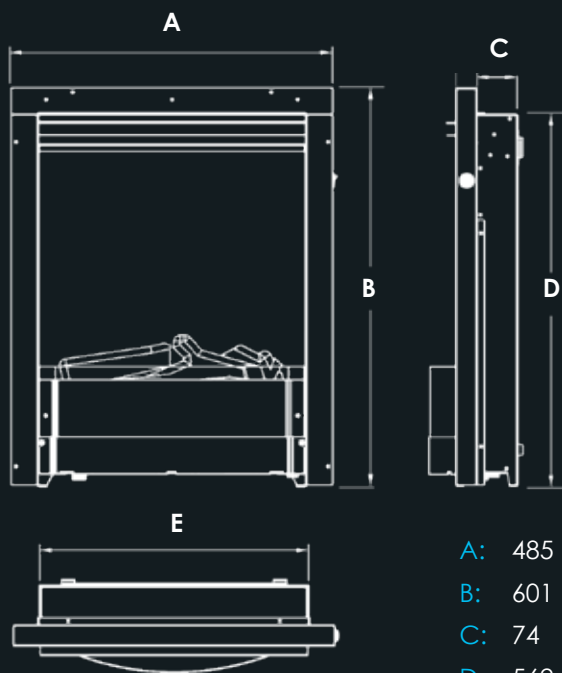

A:	485
B:	601
C:	74
D:	562
E:	407



new



# Pure 1300 *Black Series*

Heat Output: 0.8kW - 1.6kW

## Features

- Premium Handcrafted Real Log Fuel Bed
- Variable Flame, Fuel Bed & Downlight Brightness
- 3 Fuel Bed Colour Options
- Anti Reflective Front Glass
- Dark Glass Flame Screen
- Removable Decorative Log Retaining Rail
- Remote Control

## Technical Dimensions (mm)

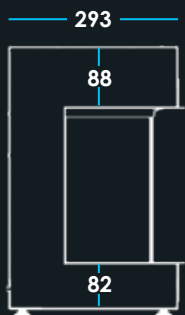
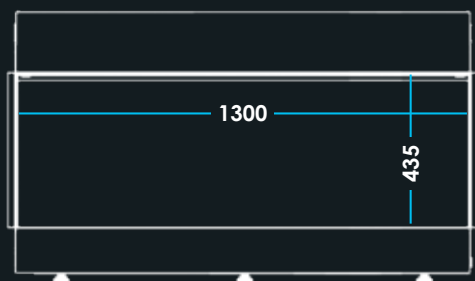

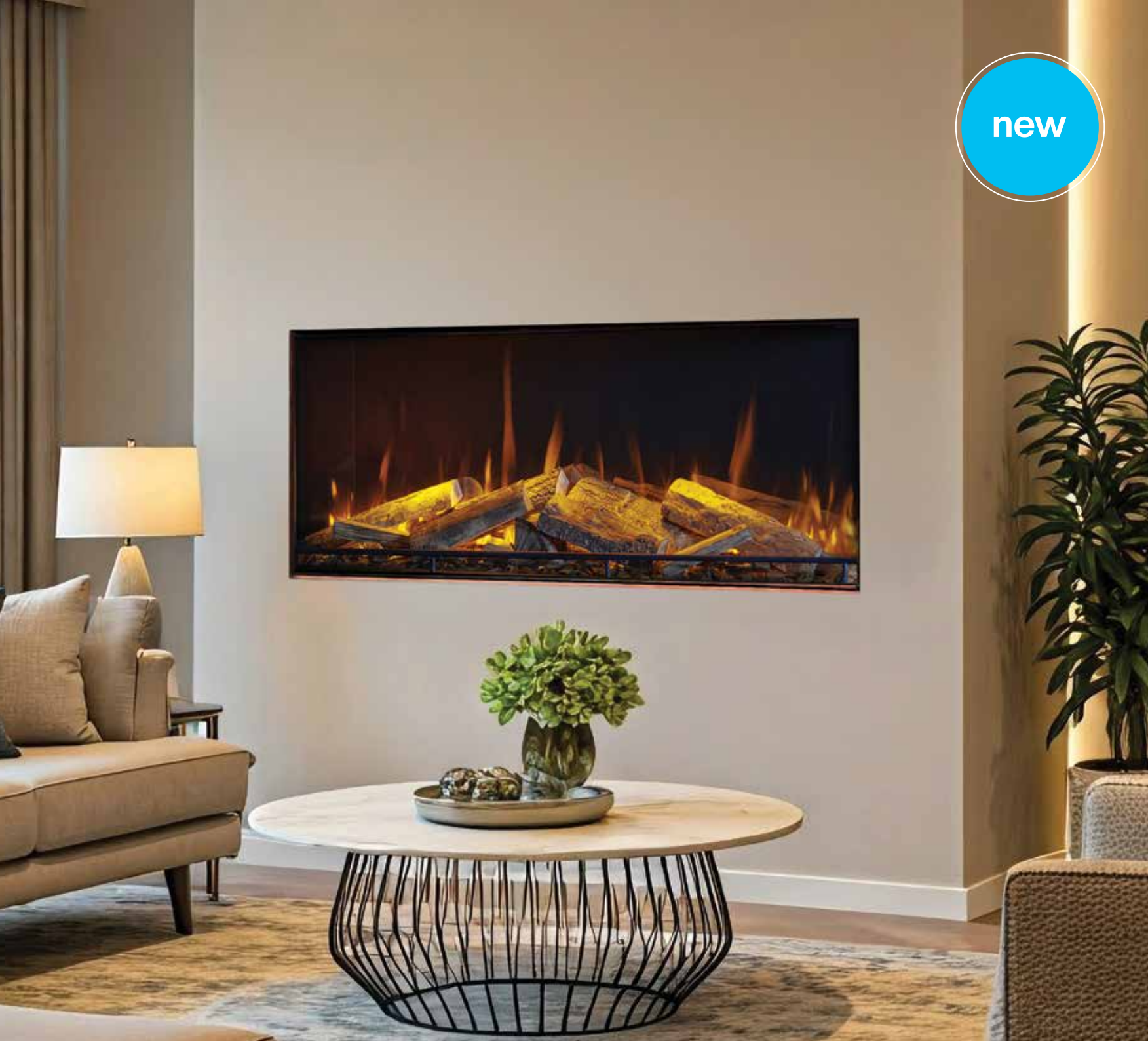

new

Installation Options

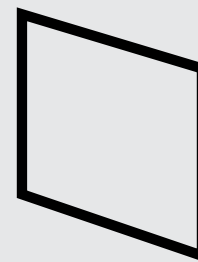

Front Facing

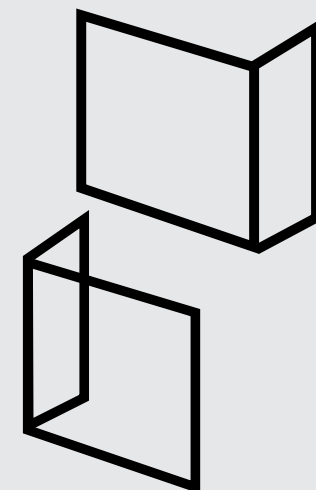

Corner (Left or Right)

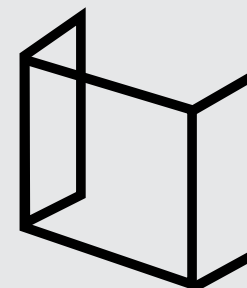

Panoramic

# Pure 1600 *Black Series*

Heat Output: 0.8kW - 1.6kW

## Features

- Premium Handcrafted Real Log Fuel Bed
- Variable Flame, Fuel Bed & Downlight Brightness
- 3 Fuel Bed Colour Options
- Anti Reflective Front Glass
- Dark Glass Flame Screen
- Removable Decorative Log Retaining Rail
- Remote Control

## Technical Dimensions (mm)

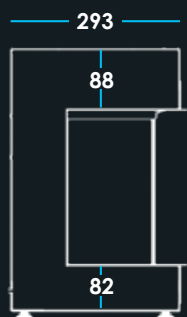
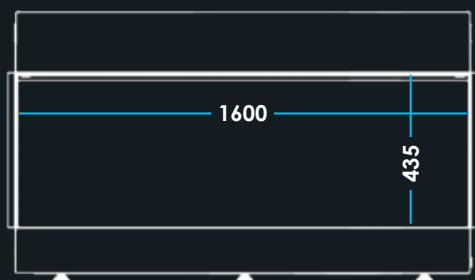



new

### Installation Options

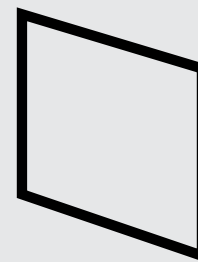

Front Facing

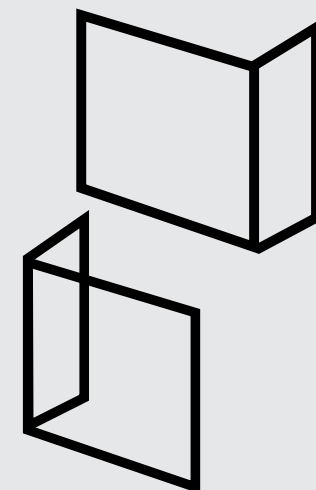

Corner (Left or Right)

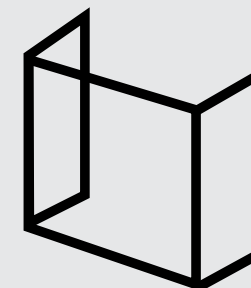

Panoramic

# Pure 1300SL *Black Series*

Heat Output: 0.8kW - 1.6kW

## Features

- Premium Handcrafted Real Log Fuel Bed
- Variable Flame, Fuel Bed & Downlight Brightness
- 3 Fuel Bed Colour Options
- Dark Glass Flame Screen
- Remote Control

## Optional Extra

- Anti Reflective Glass

## Technical Dimensions (mm)

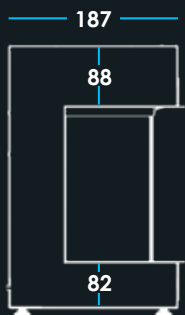
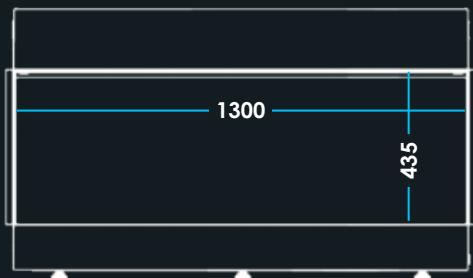

new



### Installation Options

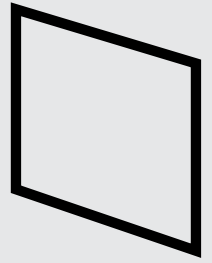

Front Facing

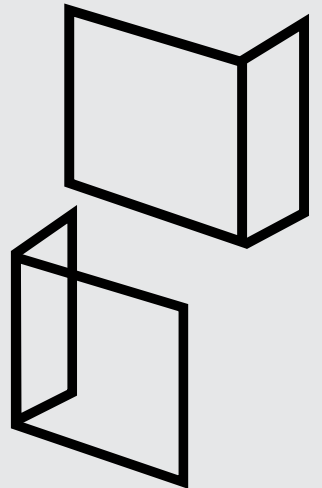

Corner (Left or Right)

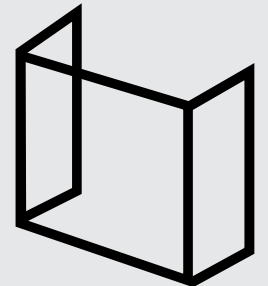

Panoramic

# Pure 1600SL *Black Series*

Heat Output: 0.8kW - 1.6kW

## Features

- Premium Handcrafted Real Log Fuel Bed
- Variable Flame, Fuel Bed & Downlight Brightness
- 3 Fuel Bed Colour Options
- Dark Glass Flame Screen
- Remote Control

## Optional Extra

- Anti Reflective Glass

## Technical Dimensions (mm)

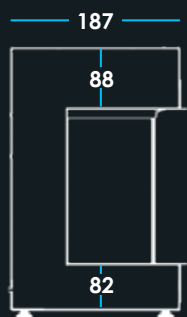
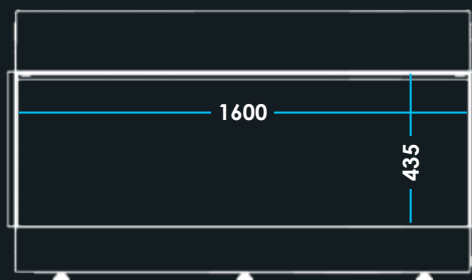



new

Installation Options

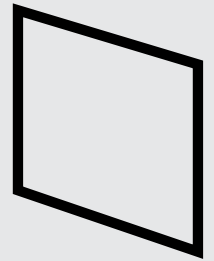

Front Facing

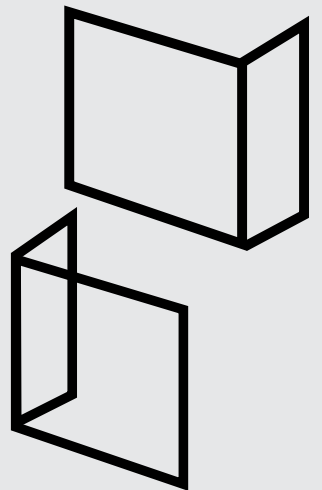

Corner (Left or Right)

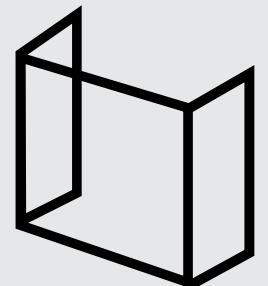

Panoramic

# LUX650 Insert

Heat Output: 1-2kW

## Features

- Premium Handcrafted Real Log Fuel Bed
- Smoked Glass Flame Screen
- Remote Control
- Solution Fires App
- Open Fronted
- Concealed Heater
- Wall Trim Included

## Technical Dimensions (mm)

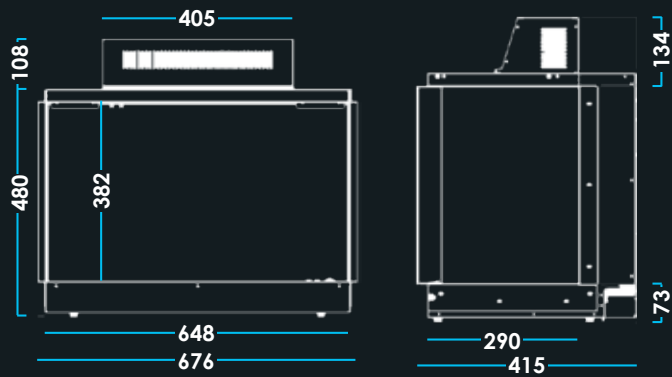

Wall Trim Dimensions: 709mm x 488mm

A minimum of 160mm is required between the top of the product and any hard surface.





Installation Options

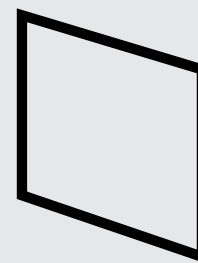

Front Facing

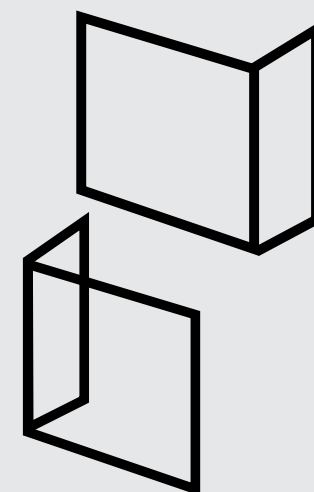

Corner (Left or Right)

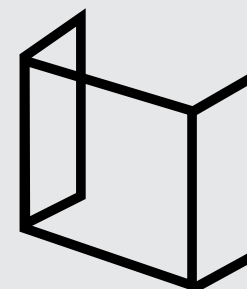

Panoramic

# LUX75

Heat Output: 0.75 - 1.5kW

## Features

- Premium Handcrafted Real Log Fuel Bed
- Remote Control
- Solution Fires App

## Optional Extras

- Black Series Upgrade
- Anti-Reflective Glass
- Scene Kit Lighting
- Solstice Basket

## Technical Dimensions (mm)

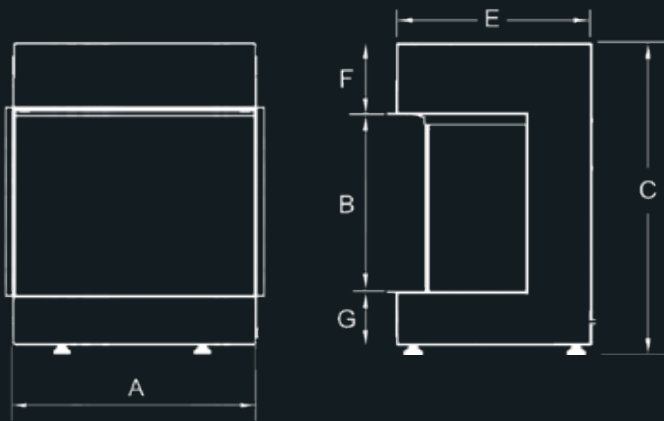

A: 750	E: 334
B: 581	F: 83
C: 737	G: 82
D: 226	





## Installation Options

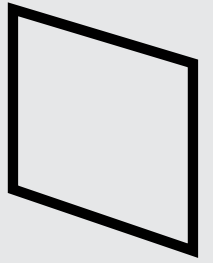

Front Facing

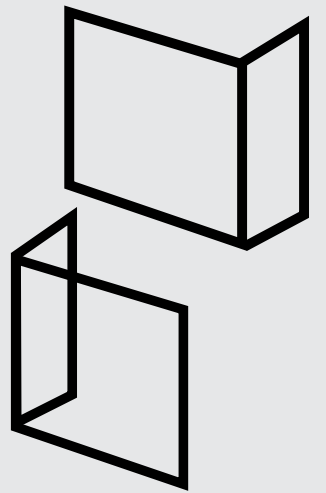

Corner (Left or Right)

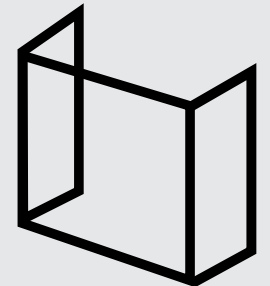

Panoramic

# LUX75 Solstice Fire Basket

Heat Output: 0.75 - 1.5kW

## Features

- Premium Handcrafted Real Log Fuel Bed
- Remote Control
- Solution Fires App

## Optional Extra

- Black Series Upgrade

## Technical Dimensions (mm)

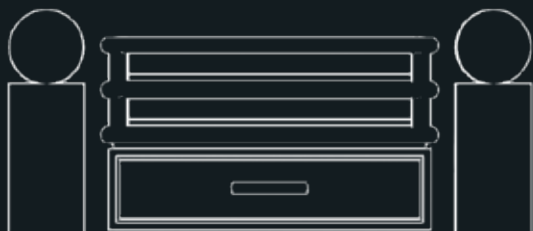

Basket	Decorative Dogs
--------	-----------------

(H) 265	(H) 280
(W) 650	(W) 100
(D) 265	(D) 100





# LUX100

Heat Output: 0.75 - 1.5kW

## Features

- Premium Handcrafted Real Log Fuel Bed
- Remote Control
- Solution Fires App

## Optional Extras

- Black Series Upgrade
- Anti-Reflective Glass
- Scene Kit Lighting

## Technical Dimensions (mm)

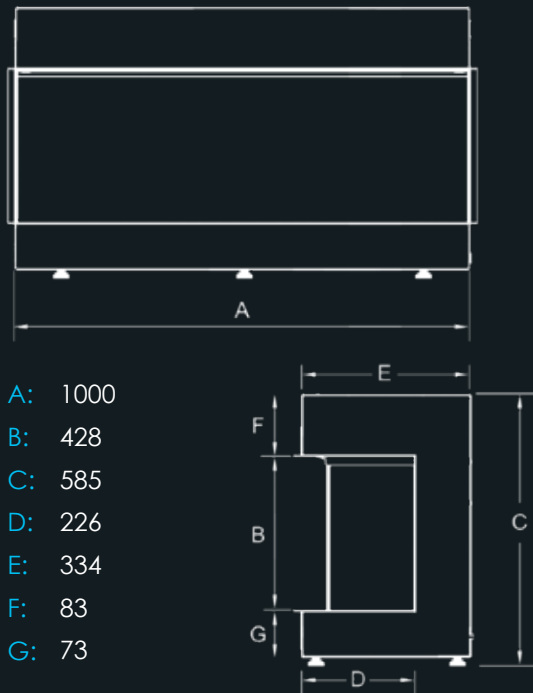



## Installation Options

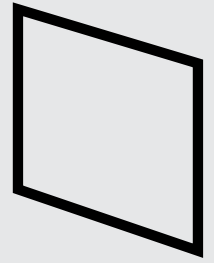

Front Facing

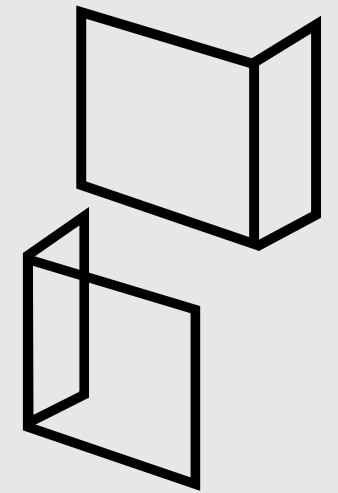
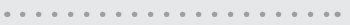

Corner (Left or Right)

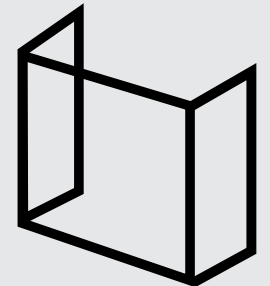
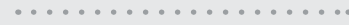

Panoramic

# LUX125

Heat Output: 1-2kW

## Features

- Premium Handcrafted Real Log Fuel Bed
- Remote Control
- Solution Fires App

## Optional Extras

- Black Series Upgrade
- Anti-Reflective Glass
- Scene Kit Lighting

## Technical Dimensions (mm)

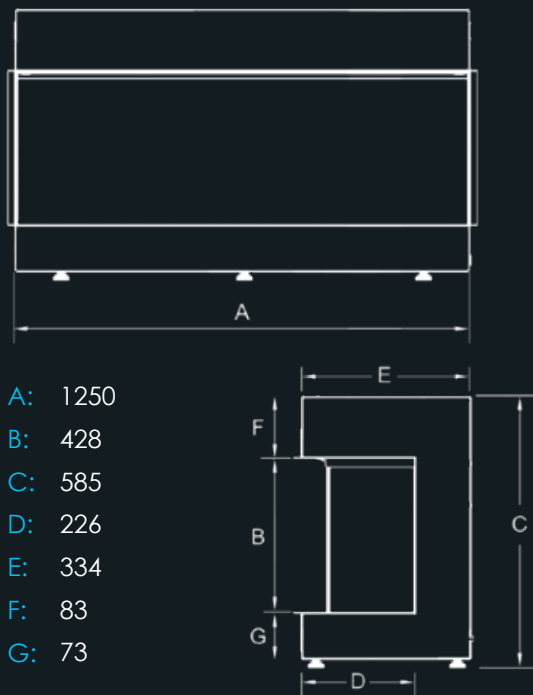



## Installation Options

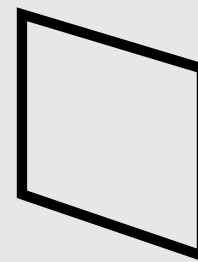

Front Facing

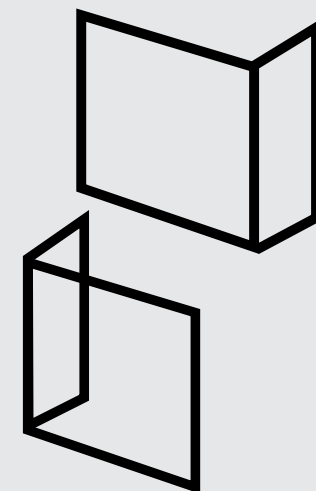

Corner (Left or Right)

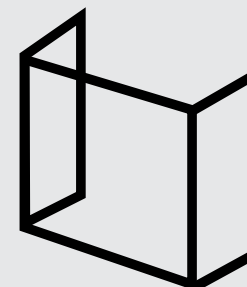

Panoramic

# LUX150

Heat Output: 1-2kW

## Features

- Premium Handcrafted Real Log Fuel Bed
- Remote Control
- Solution Fires App

## Optional Extras

- Black Series Upgrade
- Anti-Reflective Glass
- Scene Kit Lighting

## Technical Dimensions (mm)

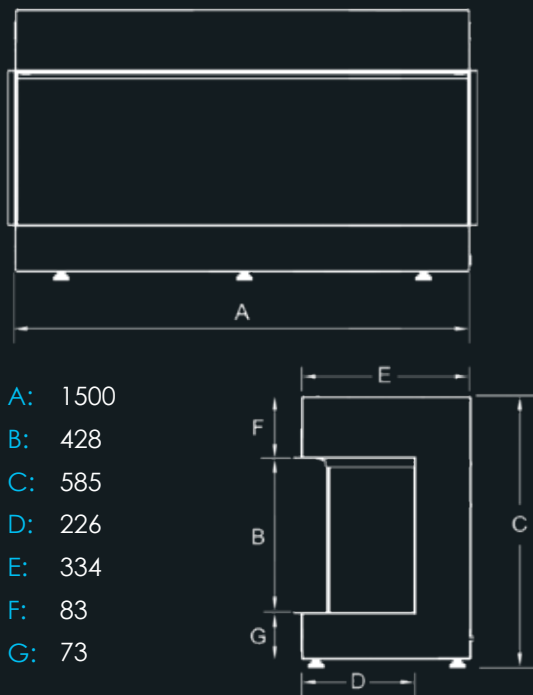



# LUX175

Heat Output: 1-2kW

## Features

- Premium Handcrafted Real Log Fuel Bed
- Remote Control
- Solution Fires App

## Optional Extras

- Anti-Reflective Glass
- Scene Kit Lighting

## Technical Dimensions (mm)

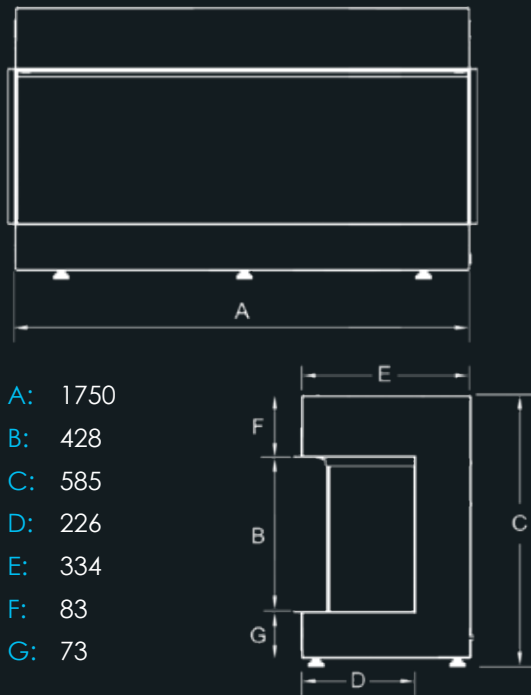



## Installation Options

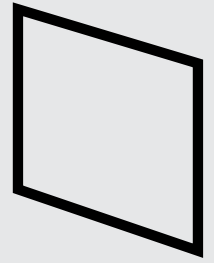

Front Facing

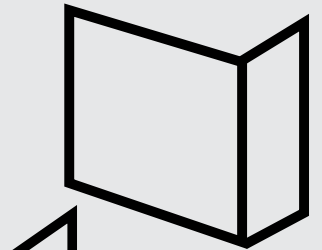

Corner (Left or Right)

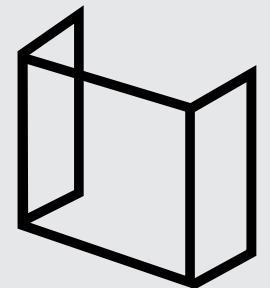
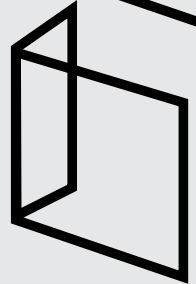

Panoramic

# LUX200

Heat Output: 1-2kW

## Features

- Premium Handcrafted Real Log Fuel Bed
- Remote Control
- Solution Fires App

## Optional Extras

- Anti-Reflective Glass
- Scene Kit Lighting

## Technical Dimensions (mm)

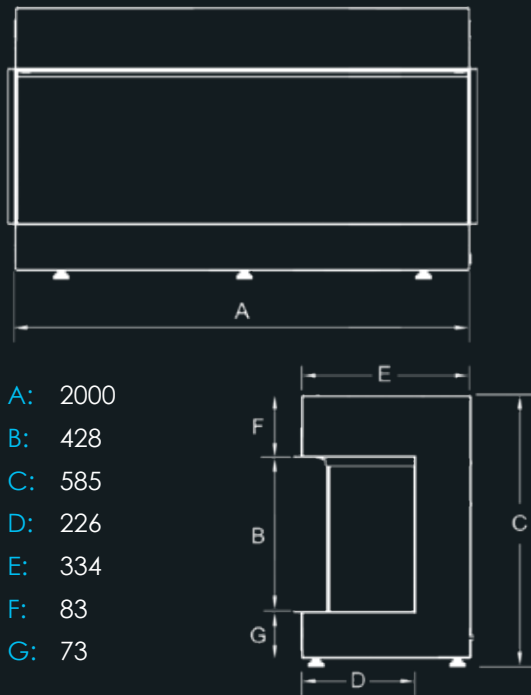



## Installation Options

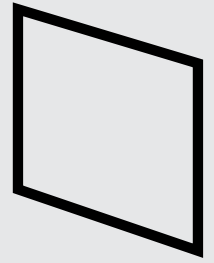

Front Facing

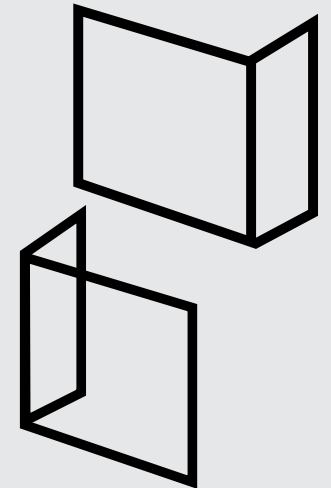

Corner (Left or Right)

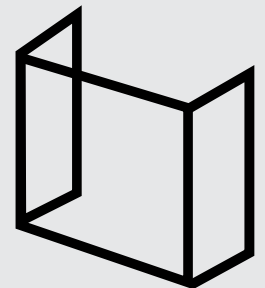

Panoramic

# LUXPLUS+ Extra Wide Feature Fire

## Create a 2.5m - 4m electric fireplace

Solution Fires have cleverly designed the LUX range of cassette fires so that they can be fitted side by side to create that extra wide WOW factor fire.\* For an enhanced visual appearance, we can provide a single front glass screen that removes the need for a central joint.

The following widths of fires can be achieved using the combination of fires:

2 x LUX125 = 2.5m Fire      2 x LUX175 = 3.5m Fire

2 x LUX150 = 3m Fire      2 x LUX200 = 4m Fire

*\*Fires order as pairs will come with special factory fitted side panels. A join in the rear flame screen will always be visible along with a gap between the two flame effects. Glass is a special order and will increase delivery times.*

### Installation Options:

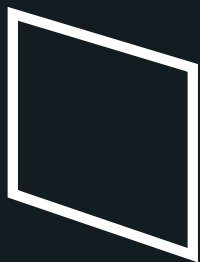

Front Facing



Corner (Left or Right)

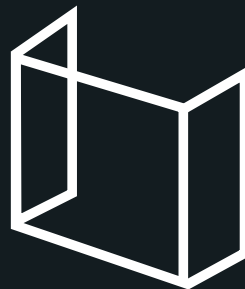

Panoramic



The UK's  
largest  
electric  
fire



# LUX & PURE Suites



## Made To Measure

All suites can be tailor made to your size requirements allowing you to create a truly bespoke installation that is perfectly suited to your space. Maximum sizes apply so we do recommend that you speak to your retailer to get more information about this service.



## Create Your Own Perfect Finish

Suites can be supplied in a primed only finish if you would prefer to get creative, opting to paint or wallpaper the components yourself. Chimney Breasts are only available in a primed finish, come flat packed and certain fixing holes will require filling after installation.



## Choose from the following finishes:

Solution Suites are available to order in a range of stylish standard and premium colours and materials.

Alternatively, we can supply your suite as primed only or colour matched to your own personal swatch. Speak with your retailer for more information.

### Painted (Standard)

Available for all suites

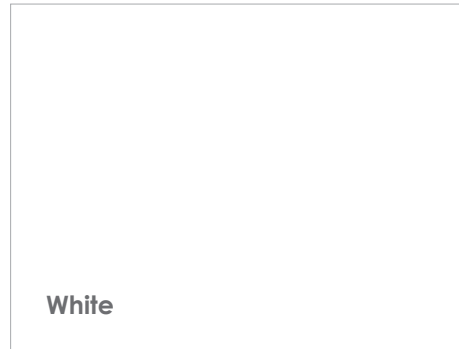

### Painted (Premium)

Available for all suites

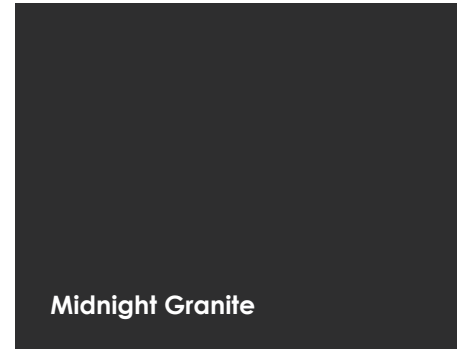

### Wood/Veneer

Available for the Sheringham with base, Brandon and Kingham suites



# Sheringham

Dimensions on page 82



# Sheringham

with Base



# SLE40i

Heat Output: 1-2kW

## Features

- Coal or Log Fuel Bed
- Remote Control
- Choice of Frames and Fascias (Pages 76-81)

## Technical Dimensions (mm)

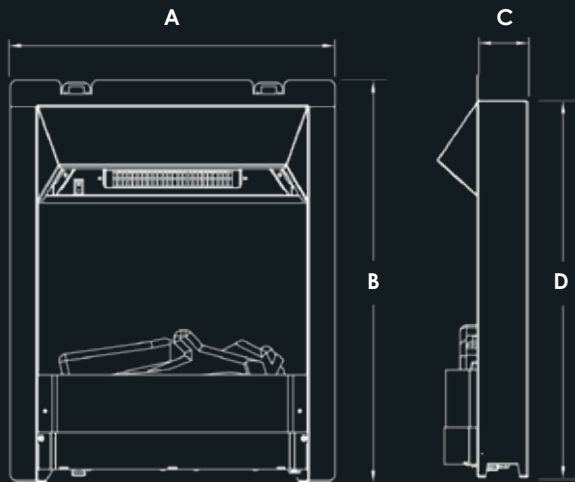

- A: 485
- B: 600
- C: 74
- D: 562
- E: 407
- F: 133





## SLE43i

Heat Output: 1-2kW

### Features

- Coal or Log Fuel Bed
- Remote Control
- Choice of Frames and Fascias (Pages 76-81)

### Technical Dimensions (mm)

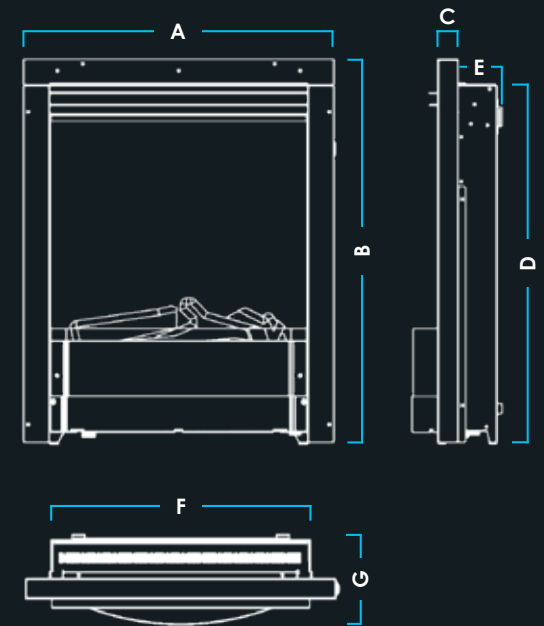

A: 485

E: 69

B: 601

F: 407

C: 32

G: 139

D: 553

# SLE43i

Glass Fronted

Heat Output: 1-2kW

## Features

- Coal or Log Fuel Bed
- Remote Control
- Choice of Frames and Fascias ((Page 76)

## Technical Dimensions (mm)

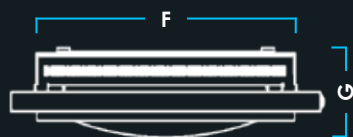
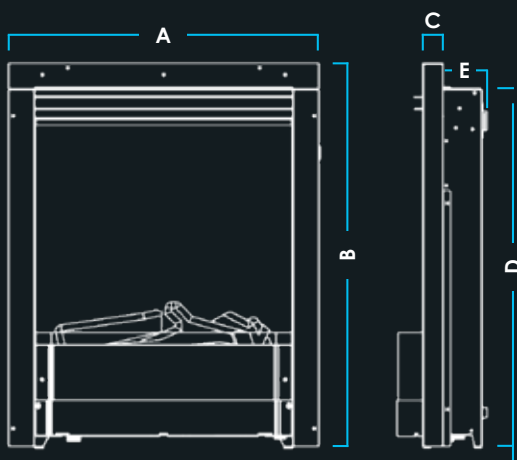

A: 485	E: 69
B: 601	F: 407
C: 77	G: 139
D: 553	





# SLE43iXD

Heat Output: 1-2kW

## Features

- Premium Handcrafted Real Log Fuel Bed
- Mirrored Side Panels
- Remote Control
- Choice of Frames and Fascias (Pages 76-81)

## Technical Dimensions (mm)

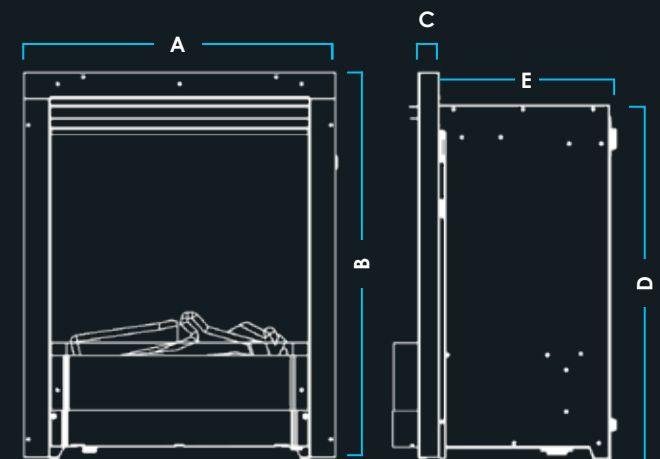

- A: 485
- B: 601
- C: 32
- D: 553
- E: 226
- F: 407
- G: 296

# SLE55i

Heat Output: 1-2kW

## Features

- Coal or Log Fuel Bed
- Remote Control
- Choice of Frames and Fascias (Page 77)

## Technical Dimensions (mm)

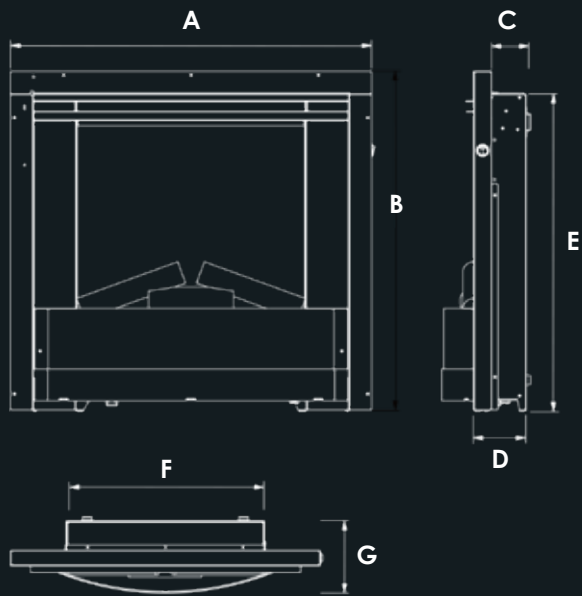

A: 638	E: 562
B: 601	F: 409
C: 61	G: 149
D: 93	





# SLE60i

Heat Output: 1-2kW

## Features

- Coal or Log Fuel Bed
- Remote Control
- Choice of Frames and Fascias (Page 77)

## Technical Dimensions (mm)

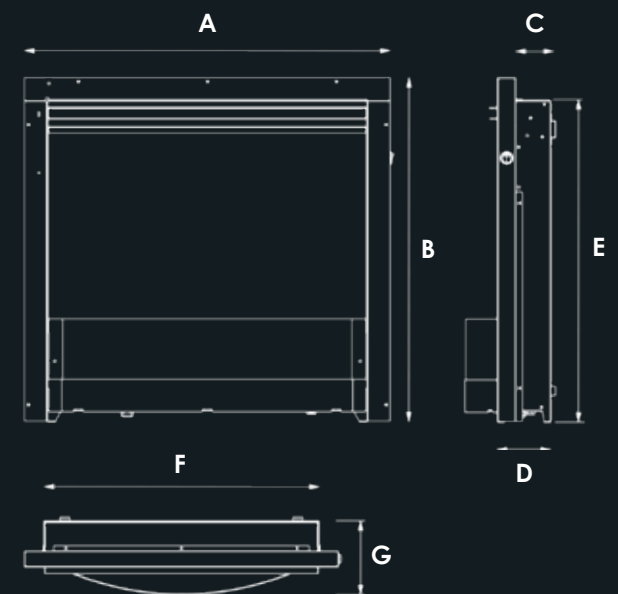

A: 638

E: 562

B: 601

F: 557

C: 61

G: 149

D: 93

# Blackthorn

Heat Output: 1-2kW

## Features

- Traditional etronic Stove
- Premium Handcrafted Real Log Fuel Bed
- Remote Control
- Decorative Flue Collar Included

## Optional Extras

- Decorative 1m Flue Pipe Extension
- **Decorative Flue Kit including:**
  - 1 x 400mm Length Flue Pipe
  - 1 x 90 Degree Bend
  - 1 x Wall Spigot
  - 1 x Stove Spigot

## Technical Dimensions (mm)

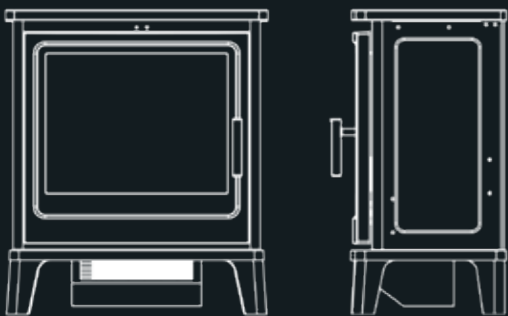

(H) 600mm (W) 520mm (D) 308mm



Black



Premium  
Real Log  
Fuel Bed

# SLE25i

Heat Output: Effect Only

## Features

- Log Fuel Bed
- Manual Control
- 8 hour Automatic Timer
- USB Rechargeable

## Technical Dimensions (mm)



**(H)** 155mm **(W)** 247mm **(D)** 180mm

*The SLE25i electric stove insert is engineered to fit in most 4-5 kW stoves. Speak to your local fireplace retailer for further advice.*





## SLE42s

Heat Output: 0.9 - 1.8kW

### Features

- Cylindrical etronic Stove
- Premium Handcrafted Real Log Fuel Bed
- Remote Control
- Decorative Flue Collar Included

### Optional Extras

- Decorative 1m Flue Pipe Extension
- **Decorative Flue Kit including:**
  - 1 x 400mm Length Flue Pipe
  - 1 x 90 Degree Bend
  - 1 x Wall Spigot
  - 1 x Stove Spigot

### Technical Dimensions (mm)



(W) 420mm (H) 951mm (D) 420mm

# SLE35i

Heat Output: 1.3kW

## Features

- Coal Effect
- Remote Control
- Flickering Flame Effect
- Glowing Coal Fuel Bed

## Technical Dimensions (mm)

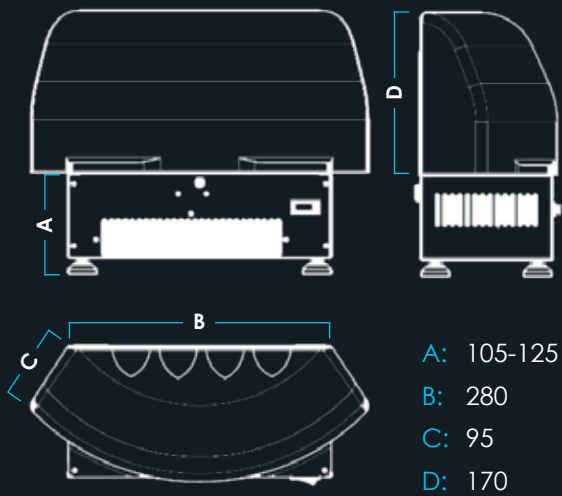



# eTronic 560

Heat Output: 1 - 2kW

## Features

- Slimline Fire
- Front, Coner or Panoramic Installation
- Ceramic Fuel Bed
- Remote Control

## Optional Extras

- Premium Real Log Fuel Bed

## Technical Dimensions (mm)

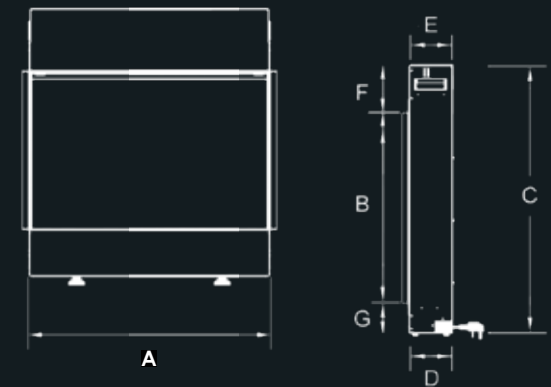

A: 567

E: 125

B: 550

F: 139

C: 786

G: 87

D: N/A

# Broadmere

## Flat Wall Suite

Heat Output: 1-2kW

### Features

- eTronic 560 Slimline Fire
- Ceramic Fuel Bed
- Remote Control
- Flat Wall Fit Suite - No Chimney Required

### Optional Extra

- Premium Real Log Fuel Bed

### Suite Options

- Corinthian Stone
- Portuguese Limestone

### Technical Dimensions (mm)

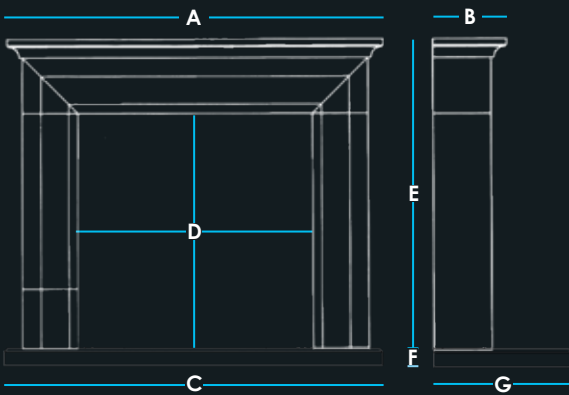

A: 1220 C: 1120 E: 1000 G: 380  
B: 235 D: 760 x 760 F: 50





# Denstone

## Flat Wall Suite

**Heat Output: 1-2kW**

### Features

- eTronic 560 Slimline Fire
- Ceramic Fuel Bed
- Remote Control
- Flat Wall Fit Suite - No Chimney Required

### Optional Extra

- Premium Real Log Fuel Bed

### Suite Options

- Corinthian Stone
- Portuguese Limestone

### Technical Dimensions (mm)

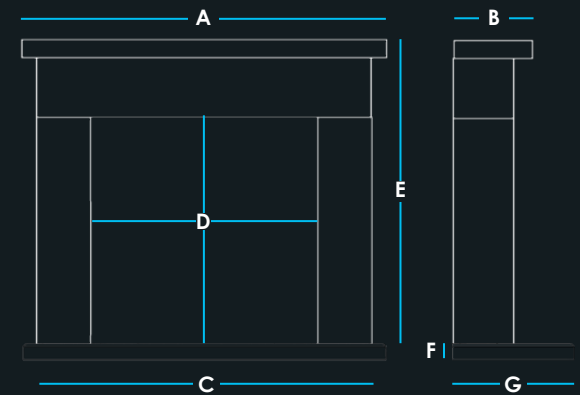

A: 1220    C: 1120    E: 990    G: 380  
 B: 250    D: 760 x 760    F: 50

# Riseley

Flat Wall Suite

Heat Output: 1-2kW

## Features

- eTronic 560 Slimline Fire
- Ceramic Fuel Bed
- Remote Control
- Flat Wall Fit Suite - No Chimney Required

## Optional Extra

- Premium Real Log Fuel Bed

## Suite Options

- Corinthian Stone
- Portuguese Limestone

## Technical Dimensions (mm)

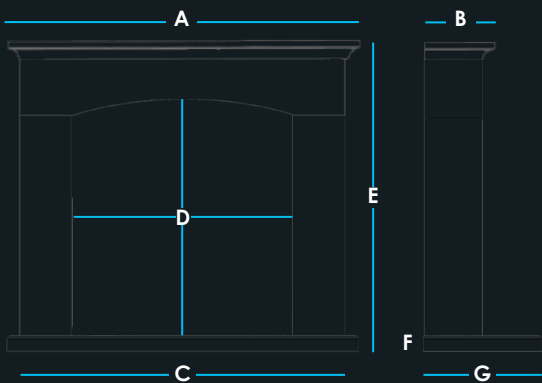

A: 1220   C: 1120   E: 1040   G: 380  
B: 250   D: 810 x 760   F: 50





new

# Arlington

## Electric Suite

- No Chimney Required
- Ambient Lighting As Standard
- Suitable For All Solution Inset Fires

### Suite Options

- 1" or 3" Rebate
- 42", 48" or 54" Shelf Width
- Powder White (Pictured)
- Smoke Grey
- Champagne Cream
- Pearl White

### Technical Dimensions (mm)

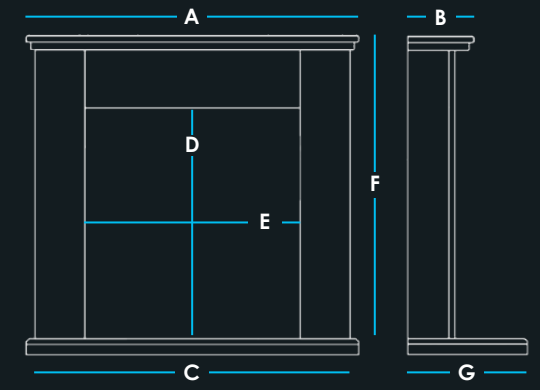

A: 1065, 1220, 1372	E: 690, 800, 860
B: 210	F: 1040, 1040, 1070
C: 1020, 1120, 1270	G: 381
D: 720, 720, 750	

# Hamlin

## Electric Suite

- No Chimney Required
- Ambient Lighting As Standard
- Suitable For All Solution Inset Fires

### Suite Options

- 1" or 3" Rebate
- 42", 48" or 54" Shelf Width
- Powder White
- Smoke Grey (Pictured)
- Champagne Cream
- Pearl White

### Technical Dimensions (mm)

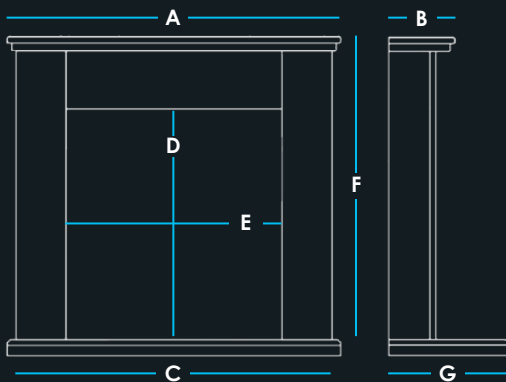

A: 1065, 1220, 1372

B: 200

C: 970, 1120, 1170

D: 740

E: 675, 825, 925

F: 1090

G: 381



new

# Lincoln

## Electric Suite

- No Chimney Required
- Ambient Lighting As Standard
- Suitable For All Solution Inset Fires

### Suite Options

- 1" or 3" Rebate
- 48" or 54" Shelf Width
- Powder White
- Smoke Grey
- Champagne Cream (Pictured)
- Pearl White

### Technical Dimensions (mm)

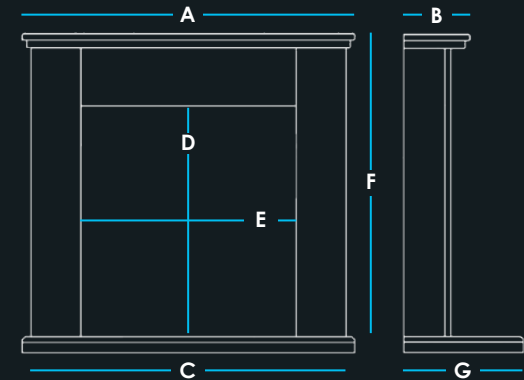

A: 1220, 1372

B: 250

C: 1120, 1270

D: 760

E: 740, 850

F: 1100

G: 381

# Mayfield

## Electric Suite

- No Chimney Required
- Ambient Lighting As Standard
- Suitable For All Solution Inset Fires

### Suite Options

- 1" or 3" Rebate
- 42", 48" or 54" Shelf Width
- Powder White
- Smoke Grey
- Champagne Cream
- Pearl White (Pictured)

### Technical Dimensions (mm)

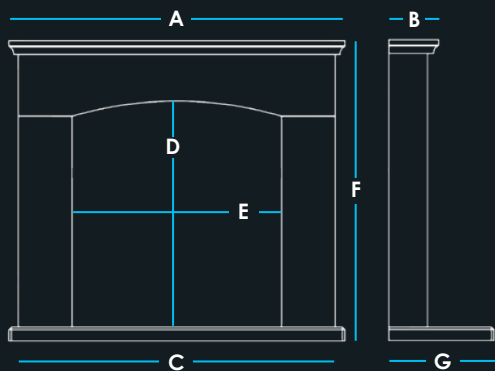

A: 1065, 1220, 1372	E: 690, 800, 860
B: 250	F: 1040, 1040, 1070
C: 1020, 1120, 1270	G: 381
D: 720, 720, 750	



new

# Springfield

## Electric Suite

- No Chimney Required
- Ambient Lighting As Standard
- Suitable For All Solution Inset Fires

### Suite Options

- 1" or 3" Rebate
- 42", 48" or 54" Shelf Width
- Powder White
- Smoke Grey
- Champagne Cream (Pictured)
- Pearl White

### Technical Dimensions (mm)

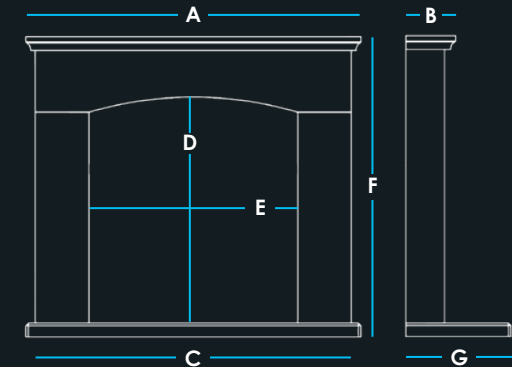

A: 1065, 1220, 1370

B: 200

C: 1020, 1120, 1270

D: 720, 720, 750

E: 690, 800, 860

F: 1040, 1040, 1070

G: 381





# Provident

Flat Wall Suite

**Heat Output: 1-2kW**

**Includes:**

- Aegean Limestone Mantel
- Provident Cast Iron Insert (Highlight or Black)
- **SLE40i** eTronic Fire
- Coal or Log Fuel Bed
- Remote Control

**Technical Dimensions (mm)**

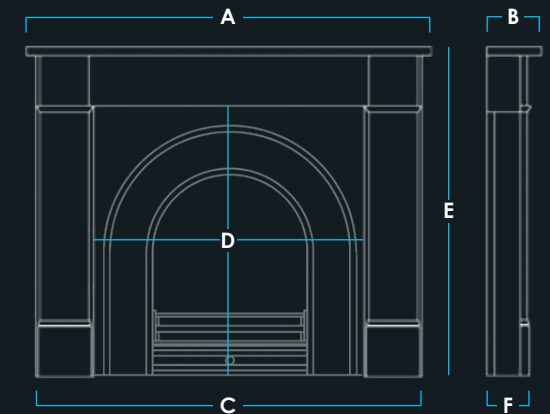

A: 1295	D: 890 x 865
B: 200	E: 1110
C: 1195	F: 140

*Provident Cast Insert 940 x 940mm*

Black

## Premium Contemporary Fascias for TF16, PURE16, SLE40i, 43i & 43iXD

(W) 520mm (H) 620mm



Duplici **brass black**



Duplici **nickel black**



Fusion **polished brushed**



Fusion **polished nickel**



Trinalis **black brass**



Trinalis **black nickel**



Trinalis **polished nickel**

## Premium XL Contemporary Fascias for SLE55i & 60i

(W) 670mm (H) 620mm



Duplici XL **black brass**



Duplici XL **black nickel**



Fusion XL **polished brushed**



Trinalis XL **black nickel**

## Contemporary Fascias for TF16, PURE 16, **SLE40i**, 43i & 43iXD

(W) 495mm (H) 608mm



Contemporary **black**



Contemporary **brass**



Contemporary **brushed**

## Classic Fireframes for **SLE40i** Halo: (W) 602mm (H) 662mm Provident: (W) 590mm (H) 740mm



Classic Halo **black**



Provident **black**



Provident **highlight**

# Magnetic Trims & Frets for TF16, SLE40i, 43i & 43iXD

(W) 510mm (H) 610mm



Trim & Bauhaus Fret  
**black**



Trim & Bauhaus Fret  
**brass**



Trim & Bauhaus Fret  
**chrome\***

\* Polished Steel Trim  
with Chrome Fret  
\*\*Brushed Steel Trim  
with Polished Fret



Trim & Bauhaus Fret  
**polished\*\***



Trim & Baltimore Fret  
**black**

## Flare Contemporary Fireframe for TF16, SLE40i, 43i & 43iXD

(W) 520mm (H) 655mm



**antique brass**



**black**



**bronze**



**brushed copper**



**dark lustre**



**polished**

## Mizar Contemporary Fireframe for TF16, SLE40i, 43i & 43iXD

(W) 520mm (H) 615mm



antique brass



black



bronze



brushed copper



dark lustre



polished

## Suite Dimensions - Sheringham

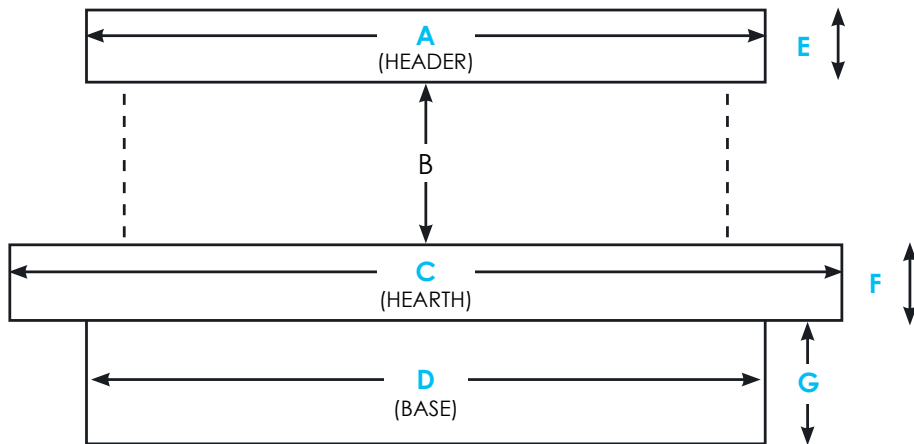

Choose A Fire	A	B	C	D	E	F	G
LUX75	1010	581	1350	1010	120	135	216
LUX100/TF100	1260	428	1600	1260	120	135	216
LUX125	1510	428	1850	1510	120	135	216
LUX150/TF150	1760	428	2100	1760	120	135	216
PURE 1300/1300SL	1560	435	1900	1560	120	135	216
PURE 1600/1600SL	1810	435	2150	1810	120	135	216

**Header Depth:** 380mm **Hearth Depth:** 410mm **Base Depth:** 360mm

**PURE & TF150/100 Header Depth:** 340mm **Hearth Depth:** 370mm **Base Depth:** 320mm

**PURE SL Header Depth:** 235mm **Hearth Depth:** 265mm **Base Depth:** 215mm





## Where To Buy

The Solution Electric Fires range is distributed via our authorised dealer network. These independent retailers are able to give you advice on all aspects of your fireplace requirements from quotations to technical and installation services. For details of your nearest retailer, please visit our website at:

[www.solutionfires.co.uk/where-to-buy](http://www.solutionfires.co.uk/where-to-buy)

## The Solution Warranty

All Solution Fires come with a standard 2 year warranty; year 1 includes parts and labour, year 2 includes parts only. Any fire purchased outside of our authorised dealer network will carry a 1 year non-extendable warranty. Standard 2 year warranty requires no registration.

For added peace of mind, we offer a 5 year Platinum Warranty Plan. To apply for the extended 5 year platinum warranty, please register your fire online at [www.solutionfires.co.uk/warranty](http://www.solutionfires.co.uk/warranty) within 60 days of the purchase date.

**Please visit our website for full terms and conditions.**



Solution Fires is a division of **Capital Fireplaces Ltd**